

D-700

INTERNET ENABLED SYNCHRONIZATION SYSTEM

EXPANSION CAPACITY

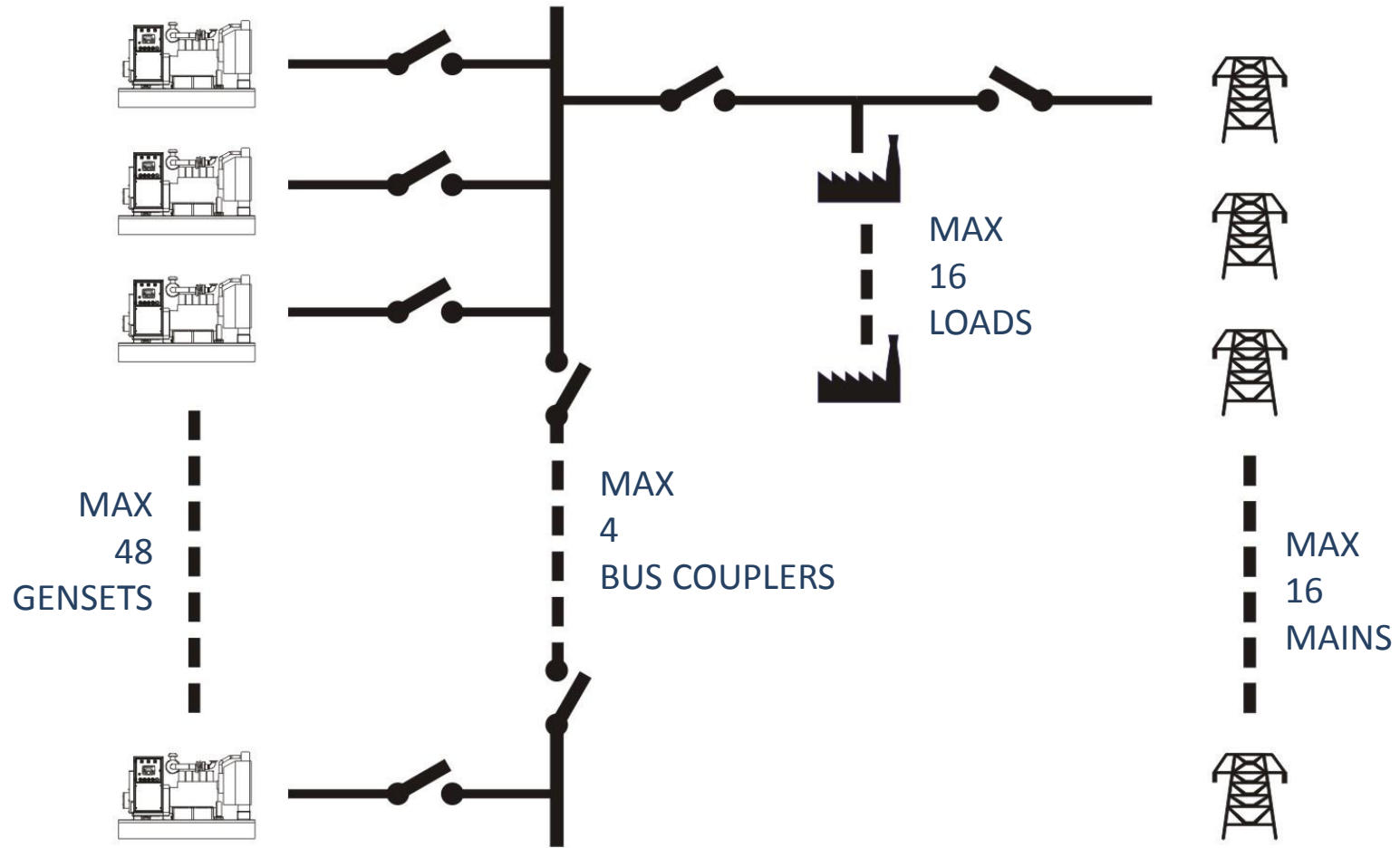

MULTIFUNCTIONAL

THE SAME UNIT IS A ...

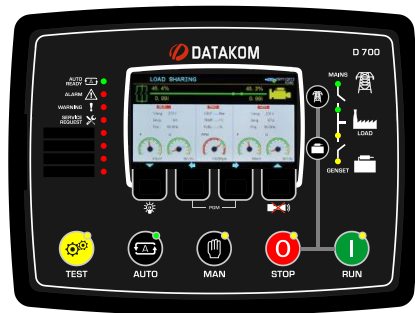

- MULTI-GENSET SYNCHRONIZER & LOAD SHARE UNIT
- MULTI-GENSET MAINS SYNCHRONIZER
- SINGLE GENSET PARALLEL WITH MAINS
- AMF UNIT WITH UNINTERRUPTED TRANSFER
- ATS CONTROLLER
- REMOTE START CONTROLLER
- ENGINE CONTROLLER
- REMOTE DISPLAY UNIT

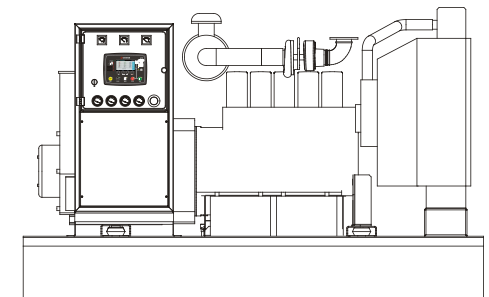

REDUCE YOUR STOCK ITEMS !



EASY PROGRAMMING

- ❑ BUILT-IN AUTOMATIC SETUP FOR SYNCH & LOAD SHARE
- ❑ EASY TO USE PC CONFIGURATION PROGRAM: RAINBOW PLUS
- ❑ PC PROGRAM CONNECTS THROUGH USB + RS485 + INTERNET
- ❑ REMOTE PARAMETER SETTING THROUGH INTERNET
- ❑ ALL PARAMETERS FRONT PANEL ADJUSTABLE
- ❑ DETAILED TRAINING MATERIAL



FLEXIBILITY

MONOCHROME & COLOR SCREEN VERSIONS AVAILABLE

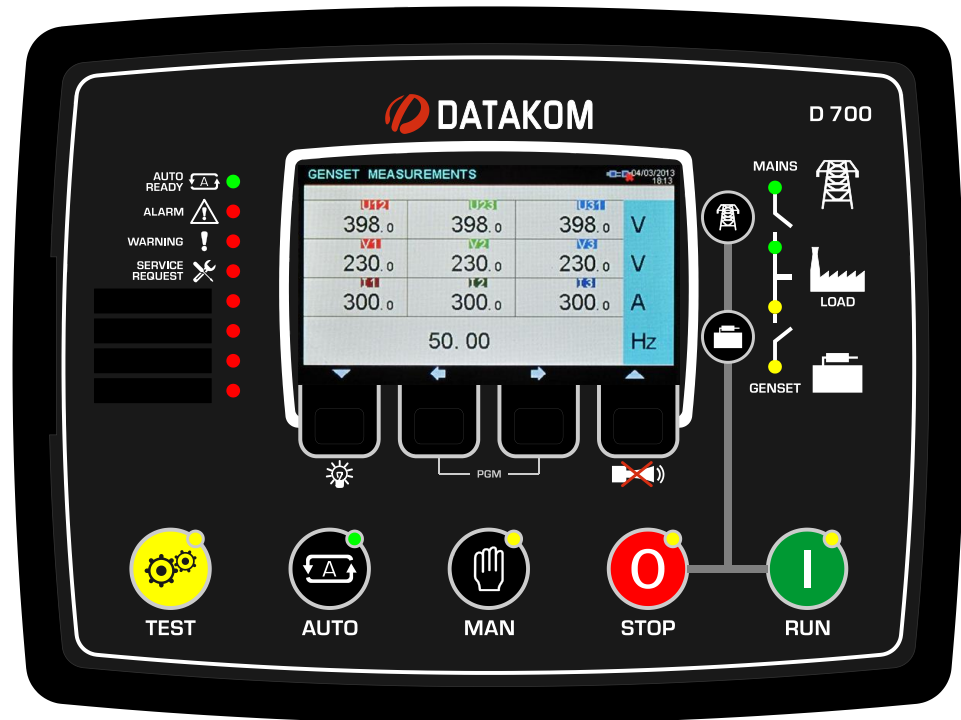
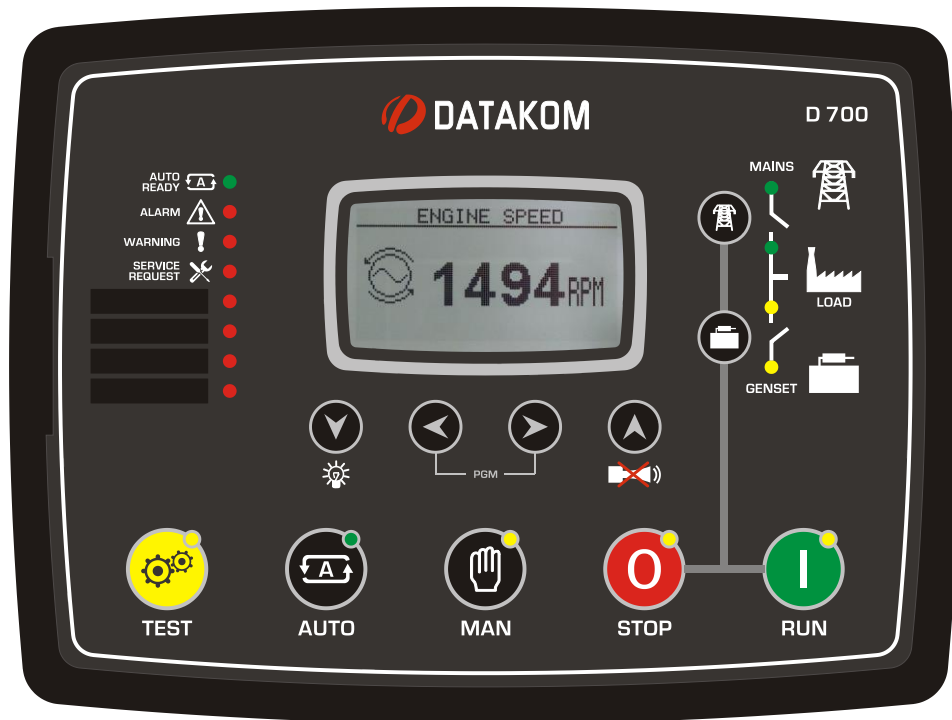

DATA PORTS

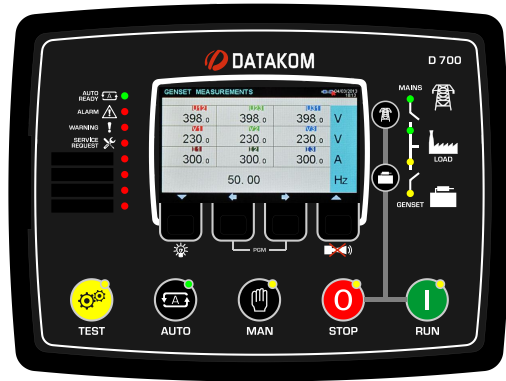

- ETHERNET 10/100 Mb
- INTERNAL GPRS MODEM
- RS-485 (MODBUS RTU)
- RS-232 (EXTERNAL MODEM)
- USB DEVICE (PC CONNECTION)
- USB HOST (LONG TERM DATA RECORDING)
- MICRO-SD CARD (LONG TERM DATA RECORDING)

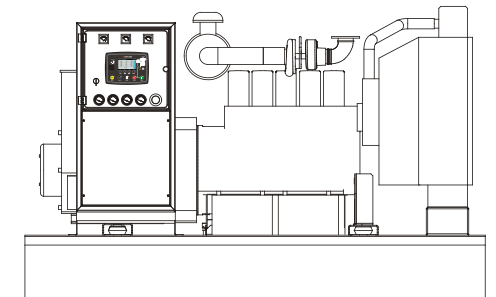

CONNECTION CAPABILITIES

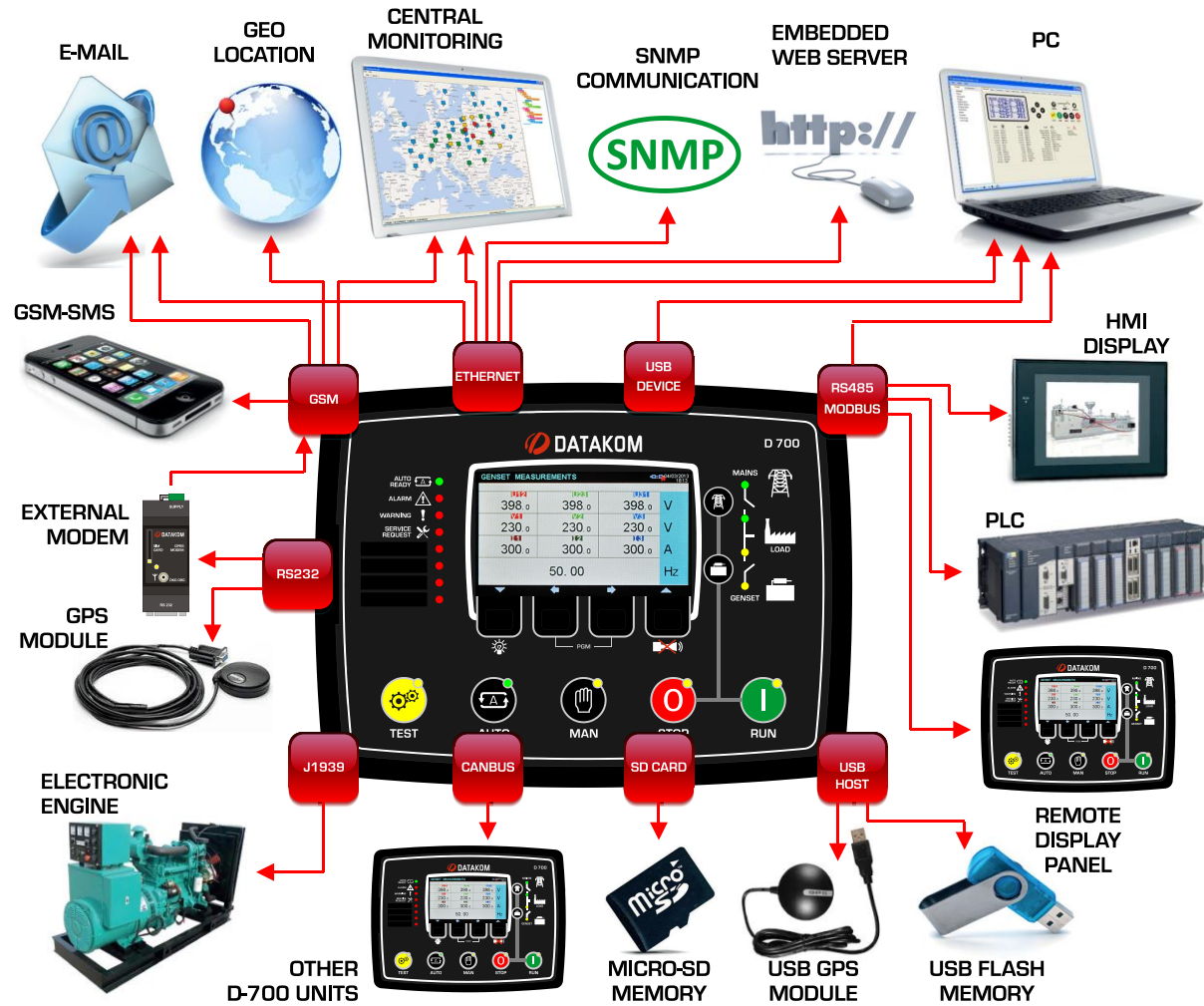

SMS SENDING

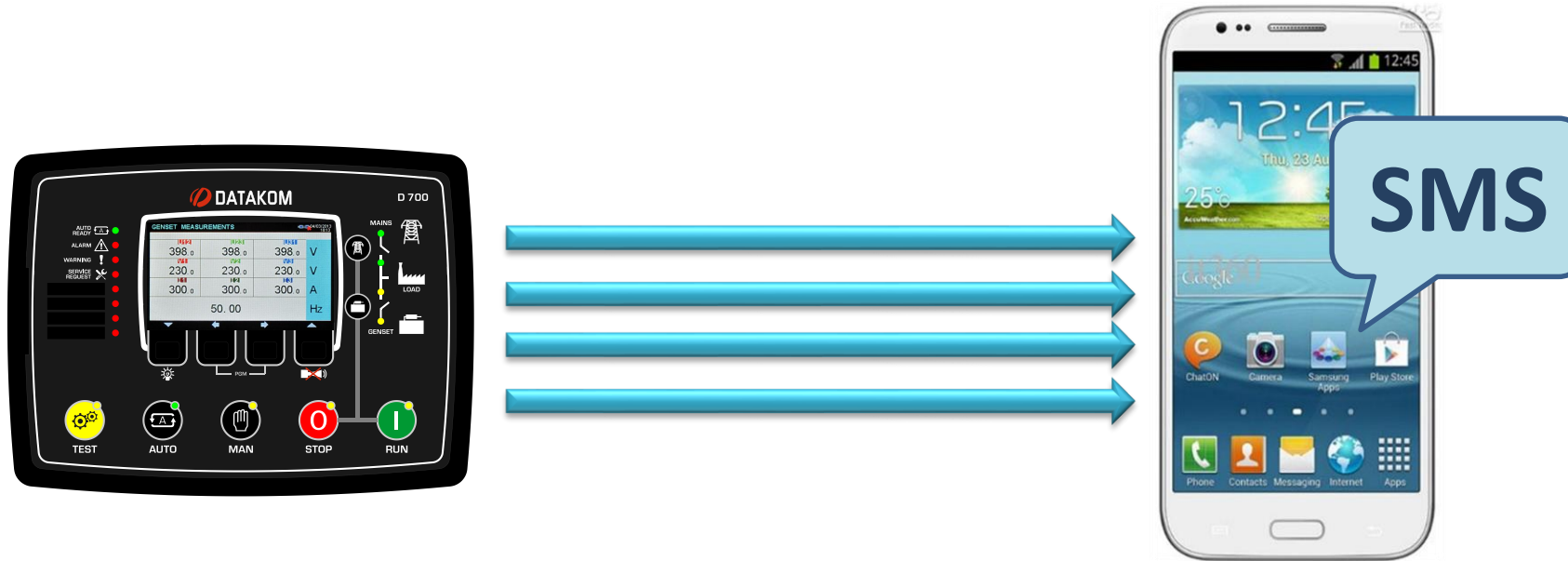

UP TO 4 DIFFERENT PHONE NUMBERS ALLOWED



E-MAIL SENDING

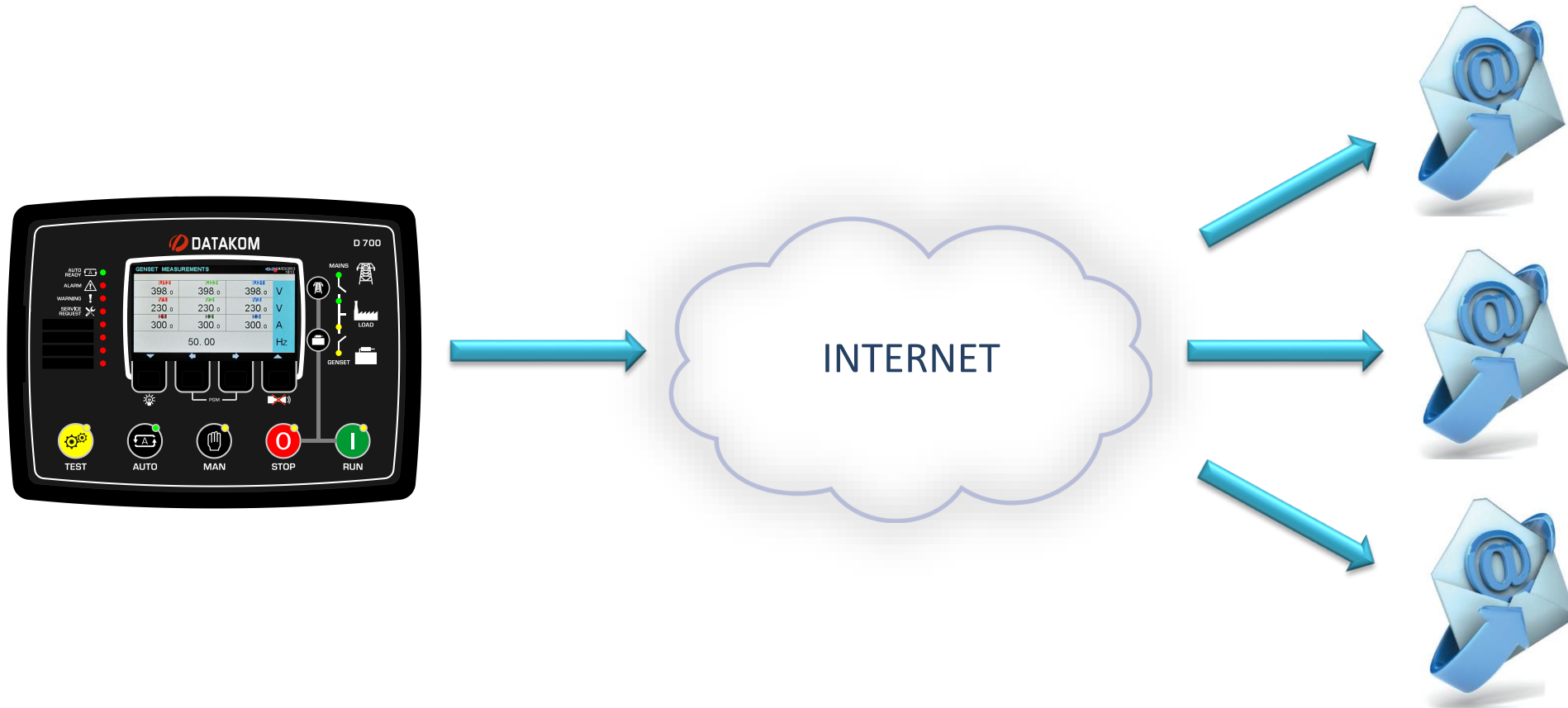

UP TO 3 DIFFERENT E-MAIL ADDRESSES ALLOWED



INTERNET FEATURES

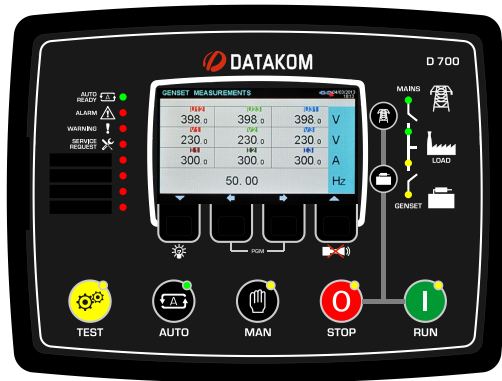

- EMBEDDED WEB SERVER
- WEB MONITORING
- WEB PROGRAMMING
- PARAMETER SETTING THROUGH INTERNET
- CENTRAL MONITORING THROUGH INTERNET
- E-MAIL SENDING
- MODBUS TCP/IP
- SNMP

SNMP



REMOTE MONITORING



INTERNET CONNECTION

LAN + GPRS CONNECTIONS ENABLED !

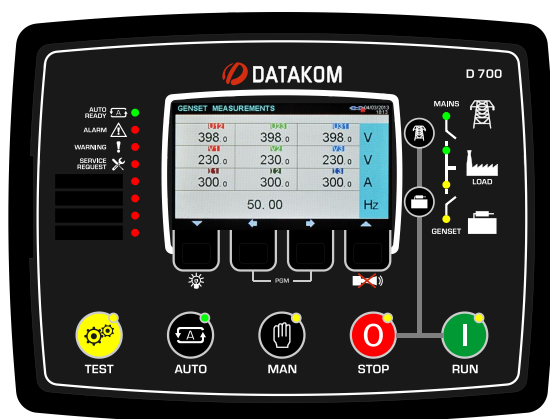

CONTROLLER

ETHERNET PORT



INTERNAL GPRS MODEM



OR

RS 232

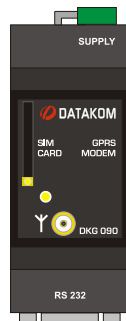

GPRS MODEM

GPRS MODEM



INTERNET

DUAL CONNECTIONS ALLOWED FOR ADDITIONAL SAFETY



EASY INSTALLATION

ETHERNET CONNECTION SUPPORTS LAN AND LOCAL IP !

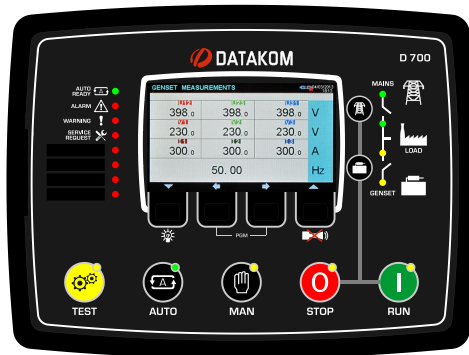

CONTROLLER



FIREWALL



RAINBOW SCADA
SERVER

- NO STATIC IP REQUIRED
- NO PORT REDIRECTION REQUIRED
- NO DATA SERVER REQUIRED
- JUST PLUG & PLAY



EASY INSTALLATION

GPRS CONNECTION SUPPORTS DYNAMIC IP AND LOCAL IP !

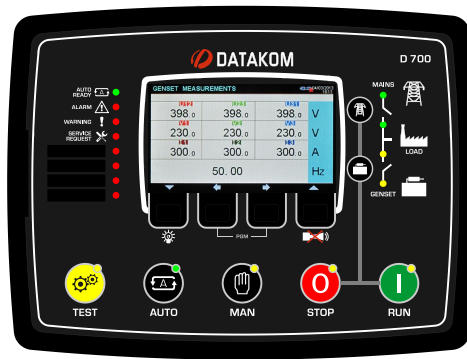

CONTROLLER

GPRS MODEM

RS 232

GPRS MODEM



DKG 090



RAINBOW SCADA
SERVER

- NO REAL IP REQUIRED
- NO STATIC IP REQUIRED
- NO DATA SERVER REQUIRED
- PLUG & PLAY WITH ANY DATA SIM CARD



RAINBOW SCADA PROGRAM

PROGRAM RUNS ON SERVER

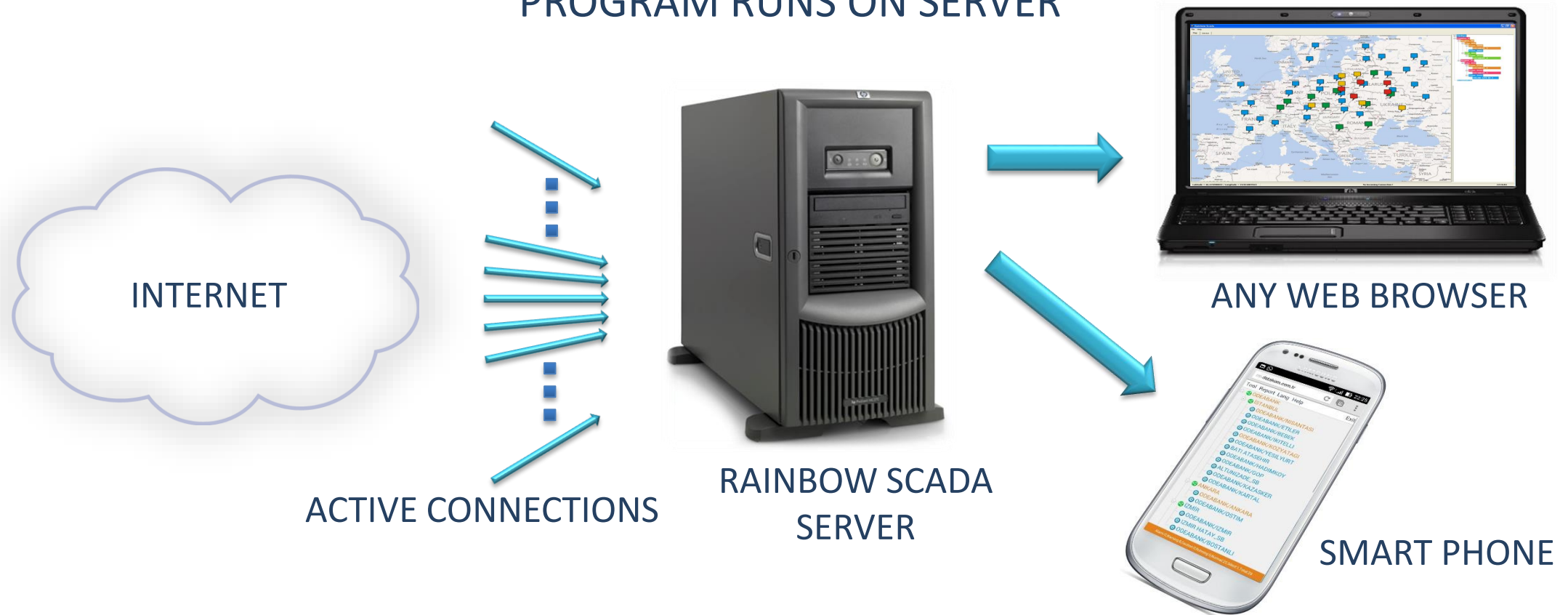

RAINBOW SCADA SERVER SUPPORTS 60'000 ACTIVE CONNECTIONS



CHART MODE DISPLAY

MONITOR YOUR COMPLETE FLEET ON ONE SCREEN

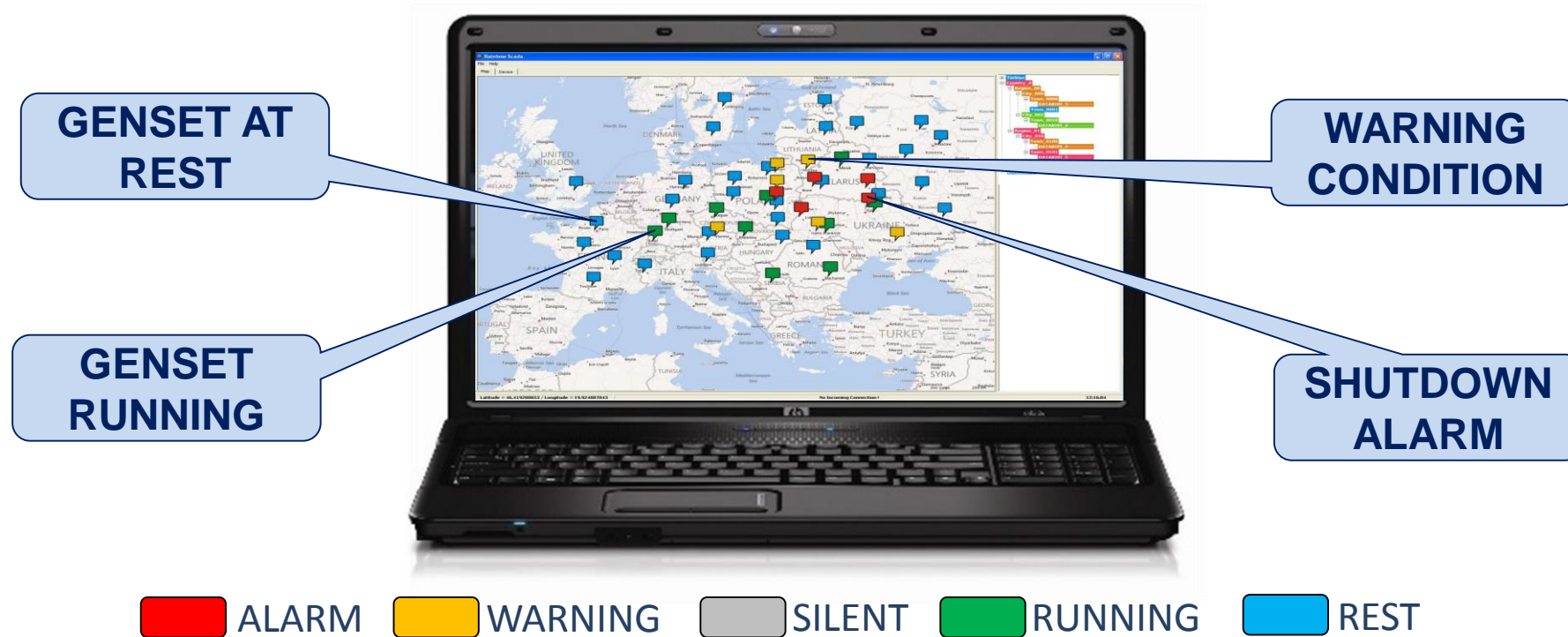

THE COLOUR OF THE BOX SHOWS DEVICE STATUS !



MOBILE GENSET SUPPORT

CONTROLLERS SHOWN AT TRUE COORDINATES WITH GPS SUPPORT

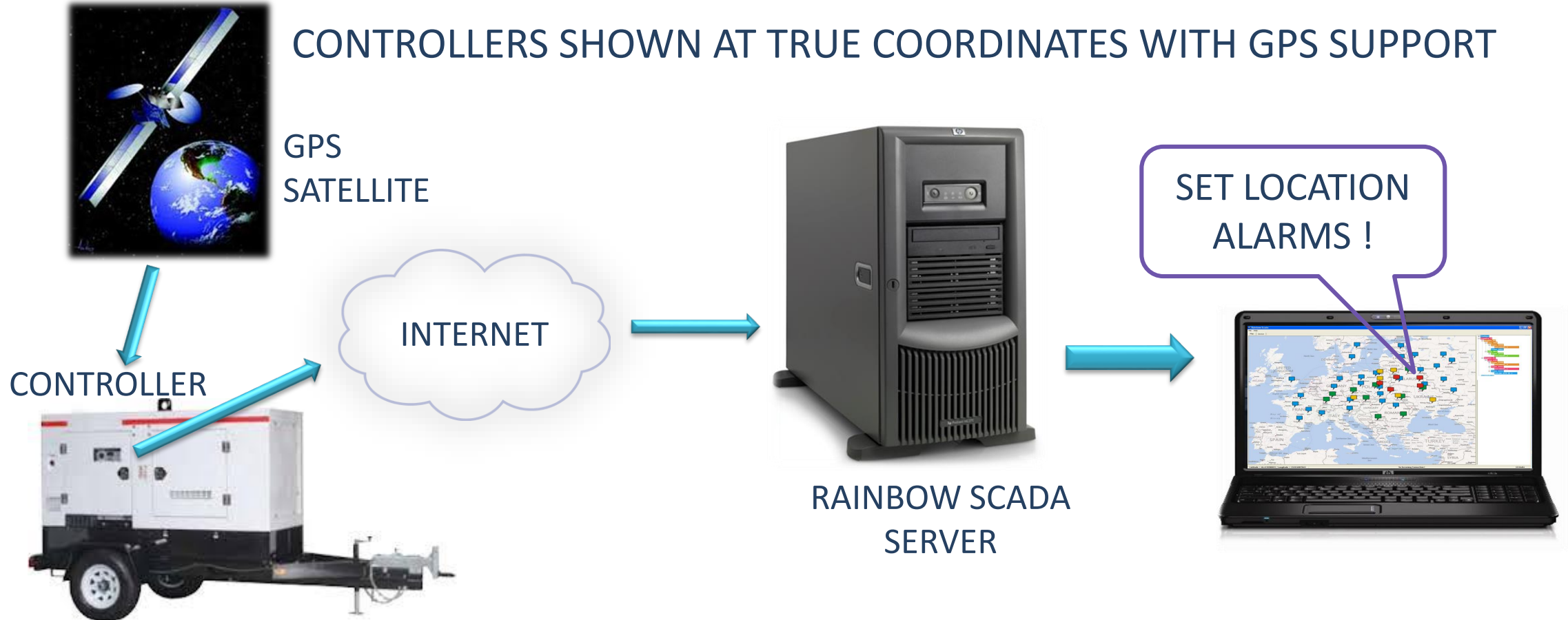

MONITOR YOUR MOBILE FLEET ON-LINE !



MOBILE GENSET SUPPORT

LOCATION DETERMINATION OVER GSM NETWORK

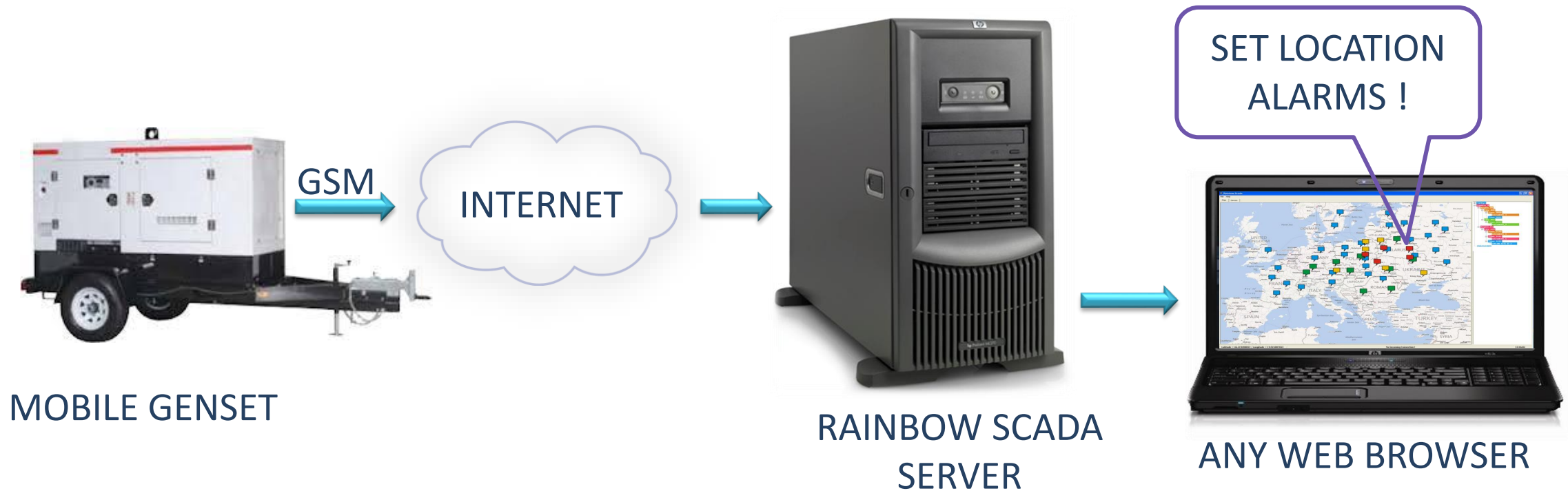

MONITOR YOUR MOBILE FLEET ON-LINE !



GROUPING OF GENSETS

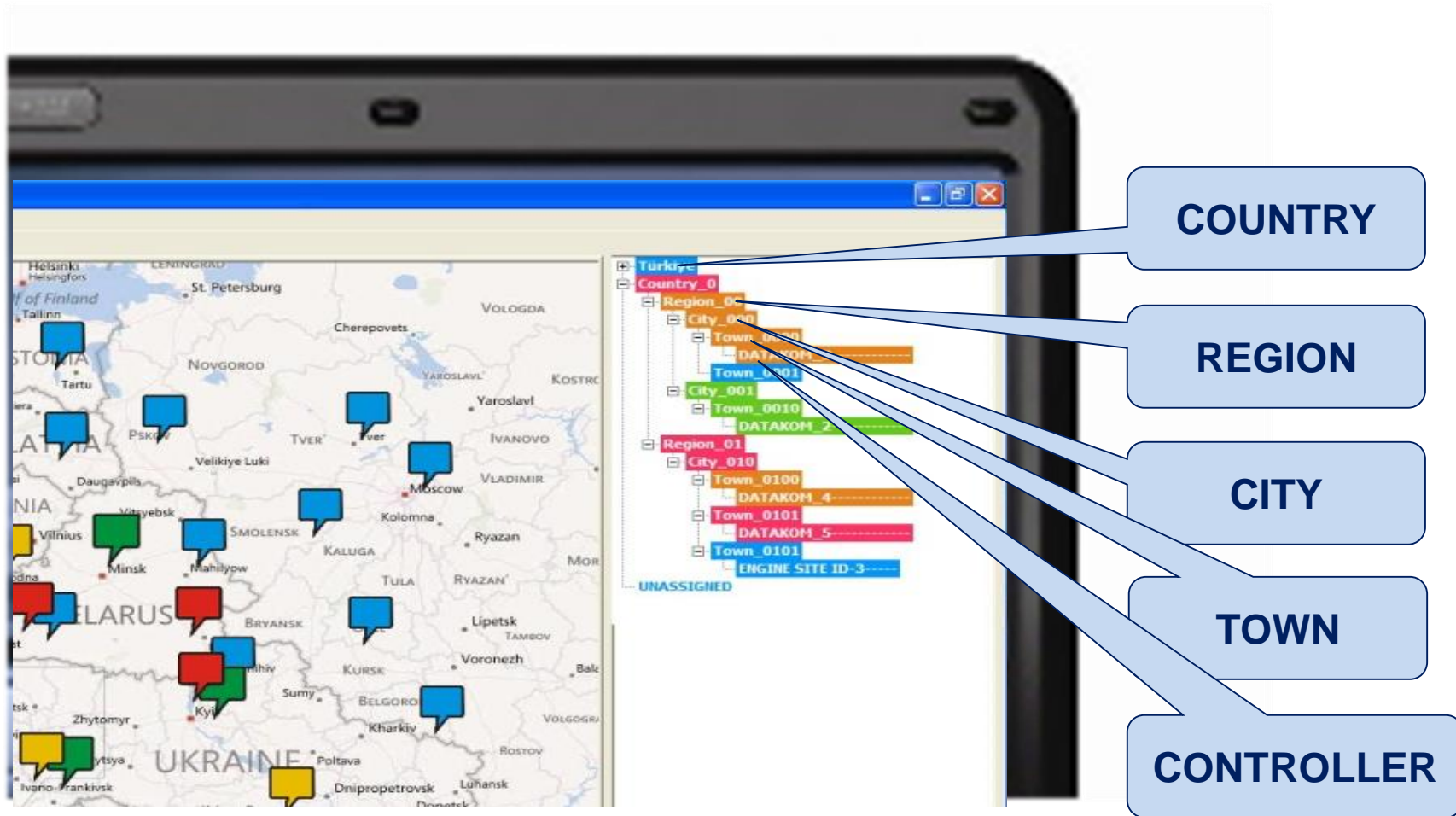

TABLET PC & SMART PHONE SUPPORT



CREATE YOUR OWN ACCOUNT

Rainbow Scada Login

datakom

••••••••

Login

Manage

LOGIN AND USE
«MANAGE»
OPTION



RAINBOW SCADA
MANAGING SCREEN

NO NEED TO WAIT FOR SUPPORT



CREATE YOUR OWN SUB_USERS

RAINBOW SCADA SERVER



RESELL YOUR DATA AND HAVE REVENUE !



DATA SECURITY

DATA IS SENT TO RAINBOW SCADA SERVER ONLY !

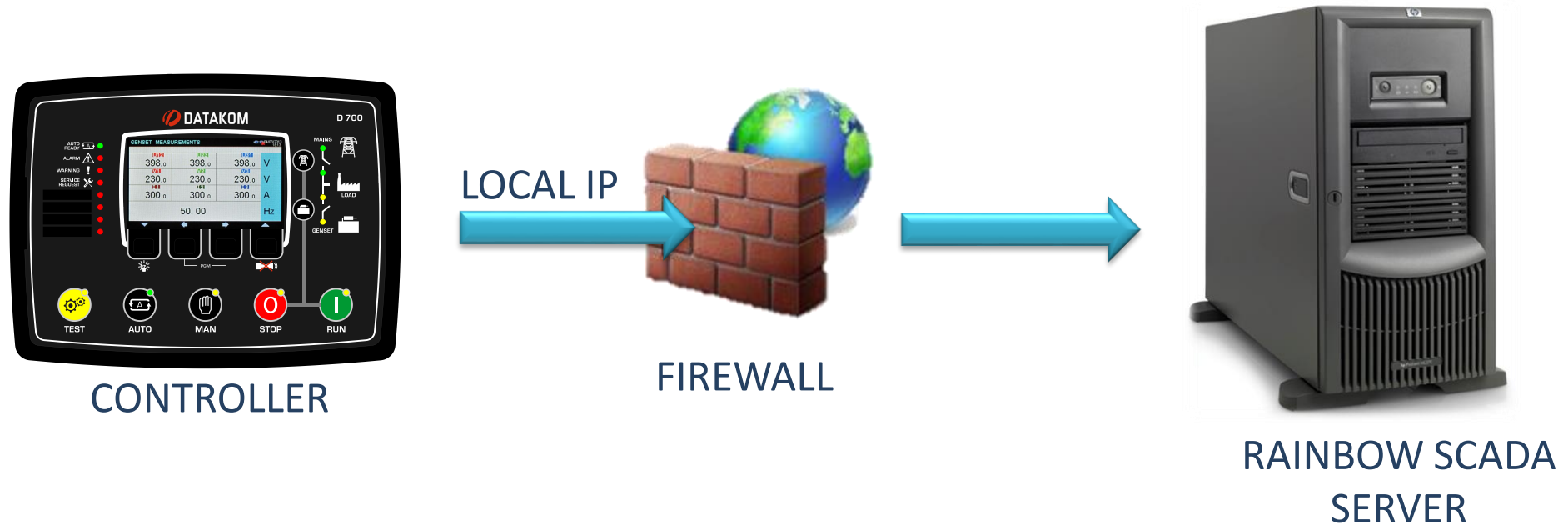

NOBODY CAN REACH YOUR CONTROLLER !



DETAIL MONITORING

MONITOR ONLINE & REAL TIME

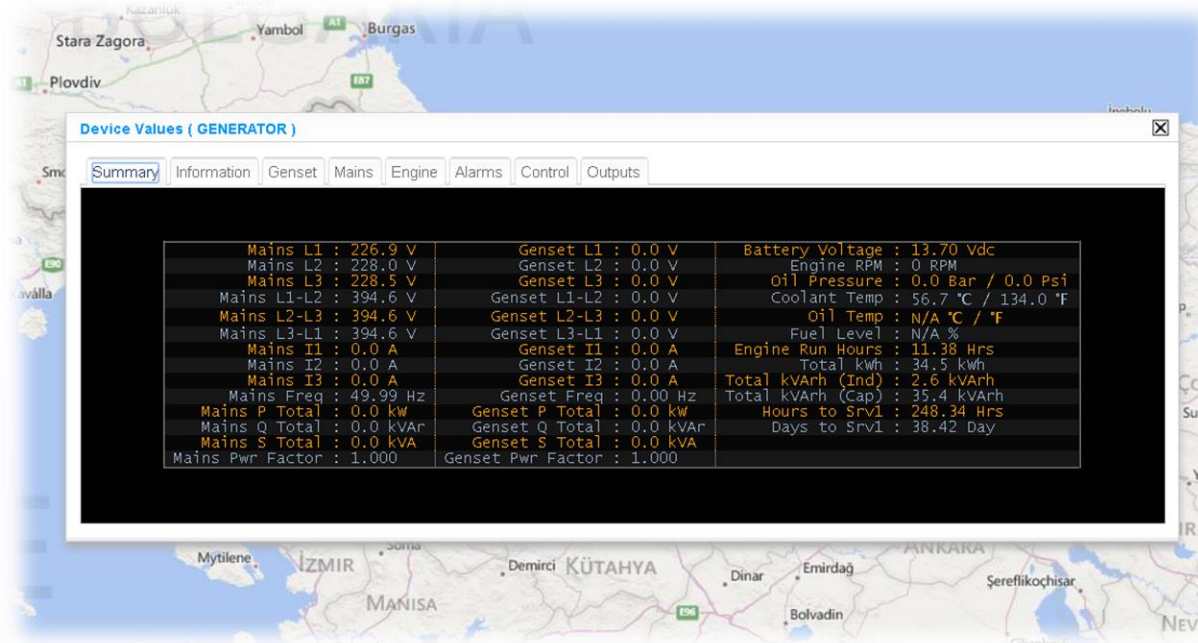

MONITOR WITH PC, TABLET OR SMARTPHONE



REMOTE ALARM MONITORING

MONITOR ONLINE & REAL TIME

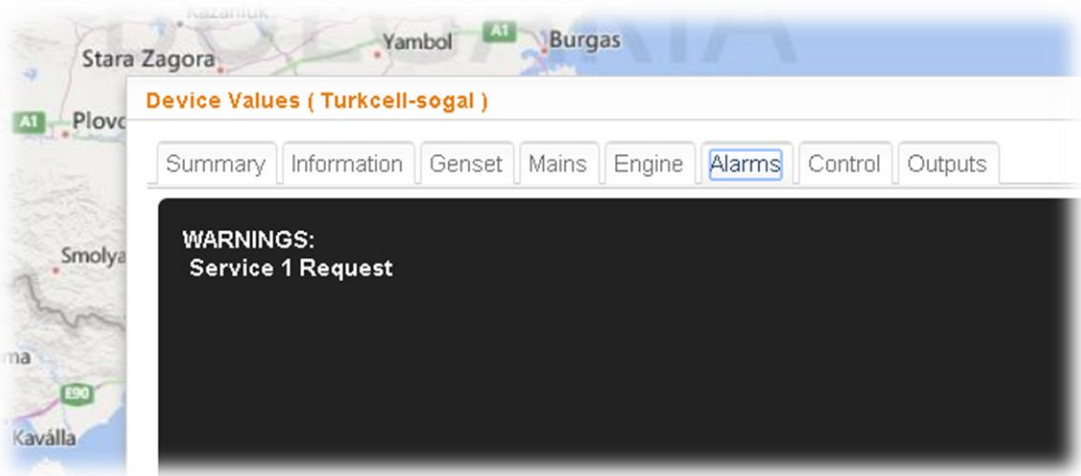

MONITOR WITH PC, TABLET OR SMARTPHONE



REMOTE CONTROL & REMOTE FAULT RESET

RESET ALARMS ONLINE & REAL TIME

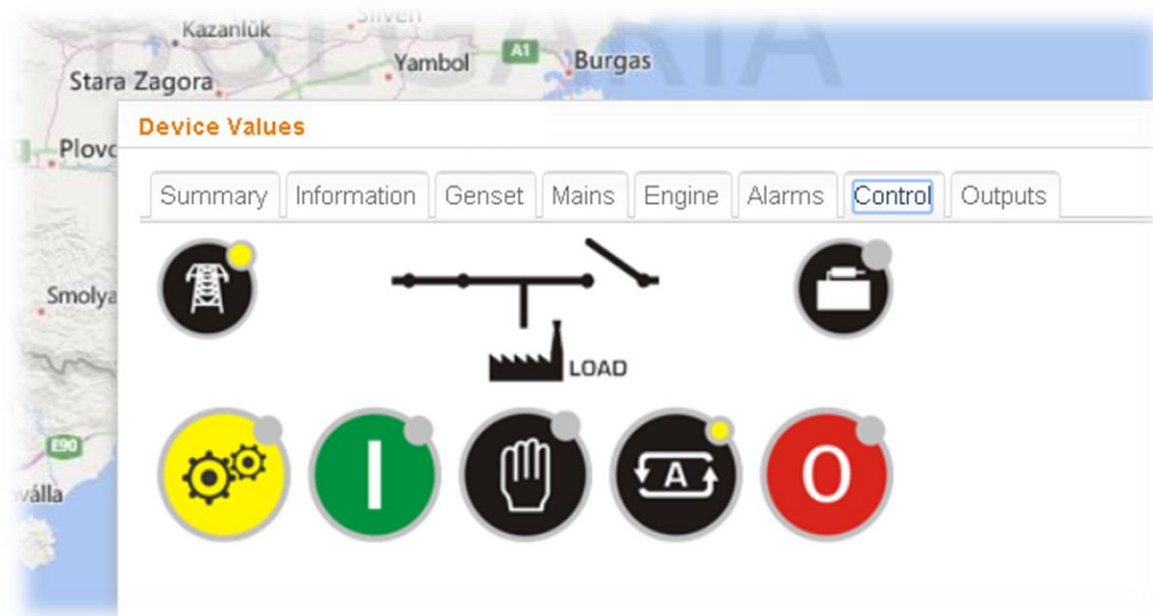

RESET ALARMS WITH PC, TABLET OR SMARTPHONE



REMOTE FAULT RESET VIA SMS

YOUR CRITICAL SITE IS ALWAYS UP !

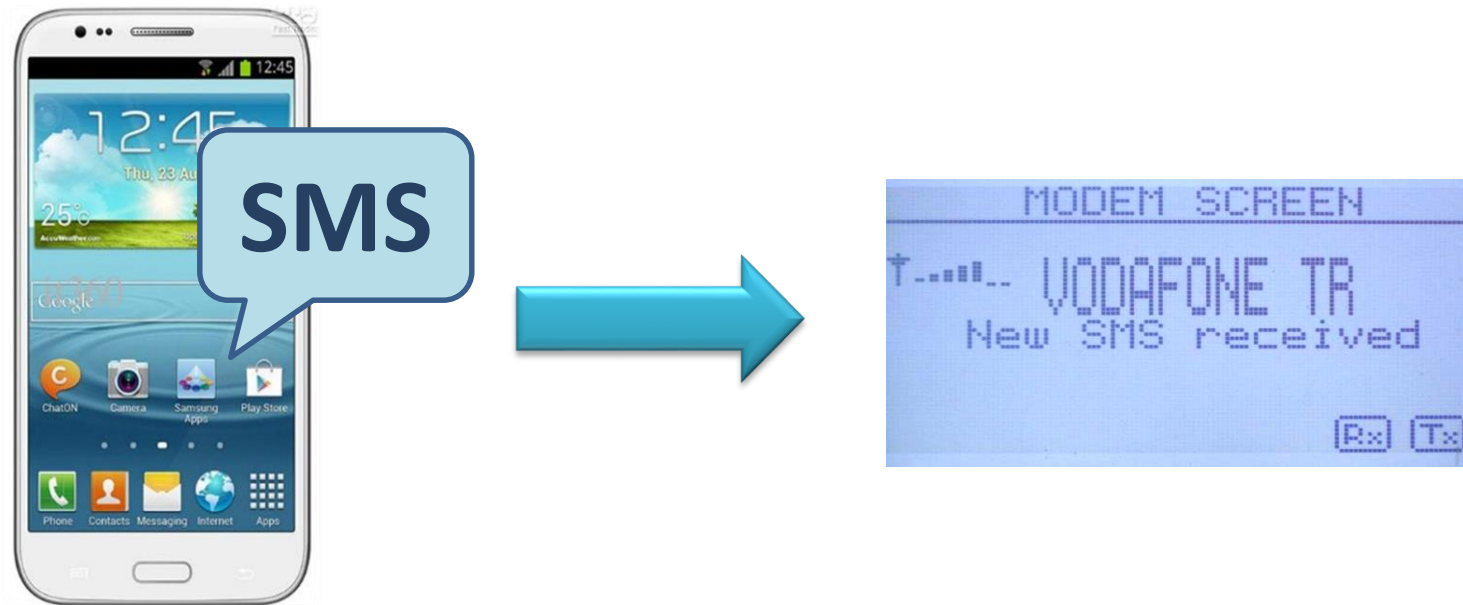

RESET ALARMS !



REMOTE PARAMETER EDIT

CONTROLLER

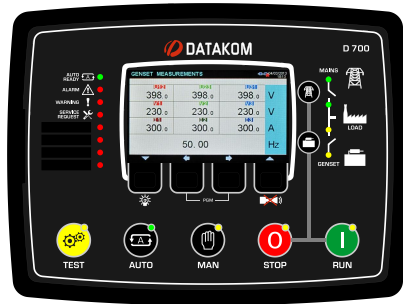

RAINBOW PLUS PROGRAM



RAINBOW SCADA SERVER

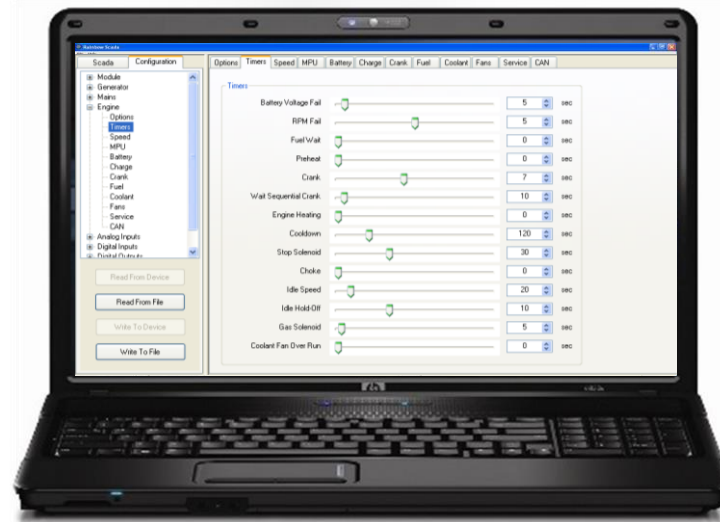

SAVE TIME AND SERVICE COST



DATA ANALYSIS

PAST DATA IS STORED ON SERVER !

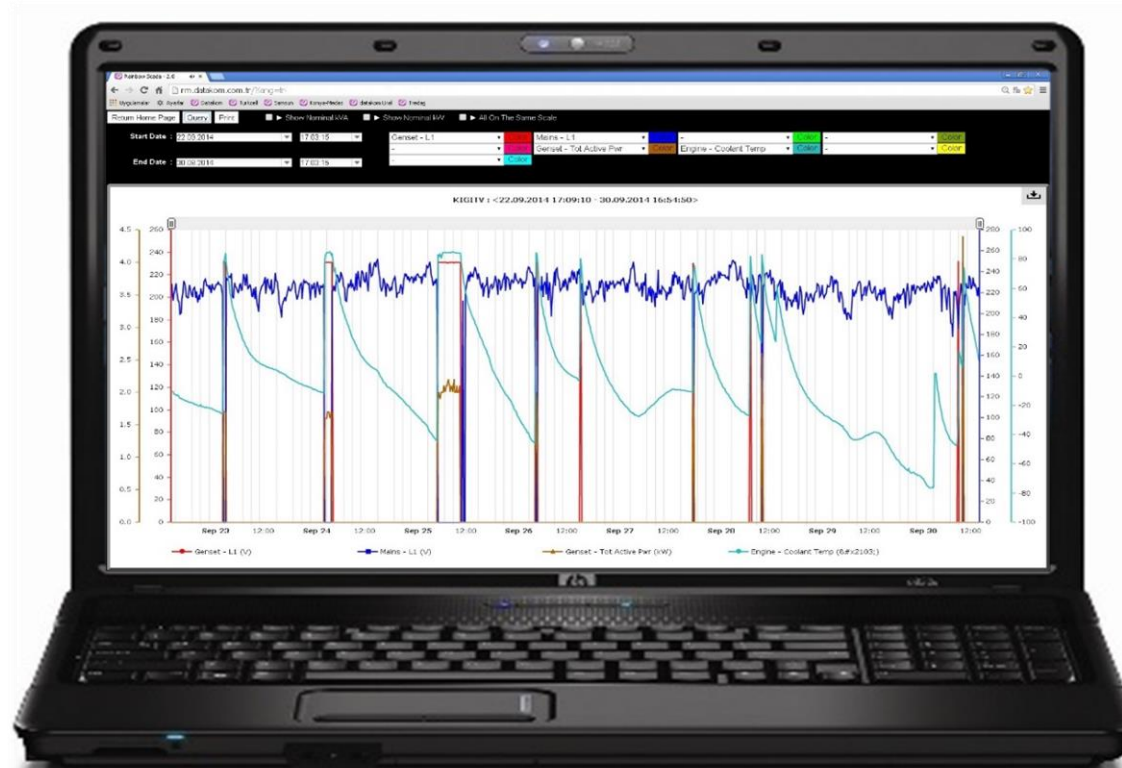

DATA CAN BE SAVED AS:

- **JPG FILES**
- **EXCEL FILES**

ANALYSE PAST PERFORMANCE OF YOUR SYSTEM !



ONLINE ALARM MANAGEMENT

DESIGNED FOR CONTROL CENTERS

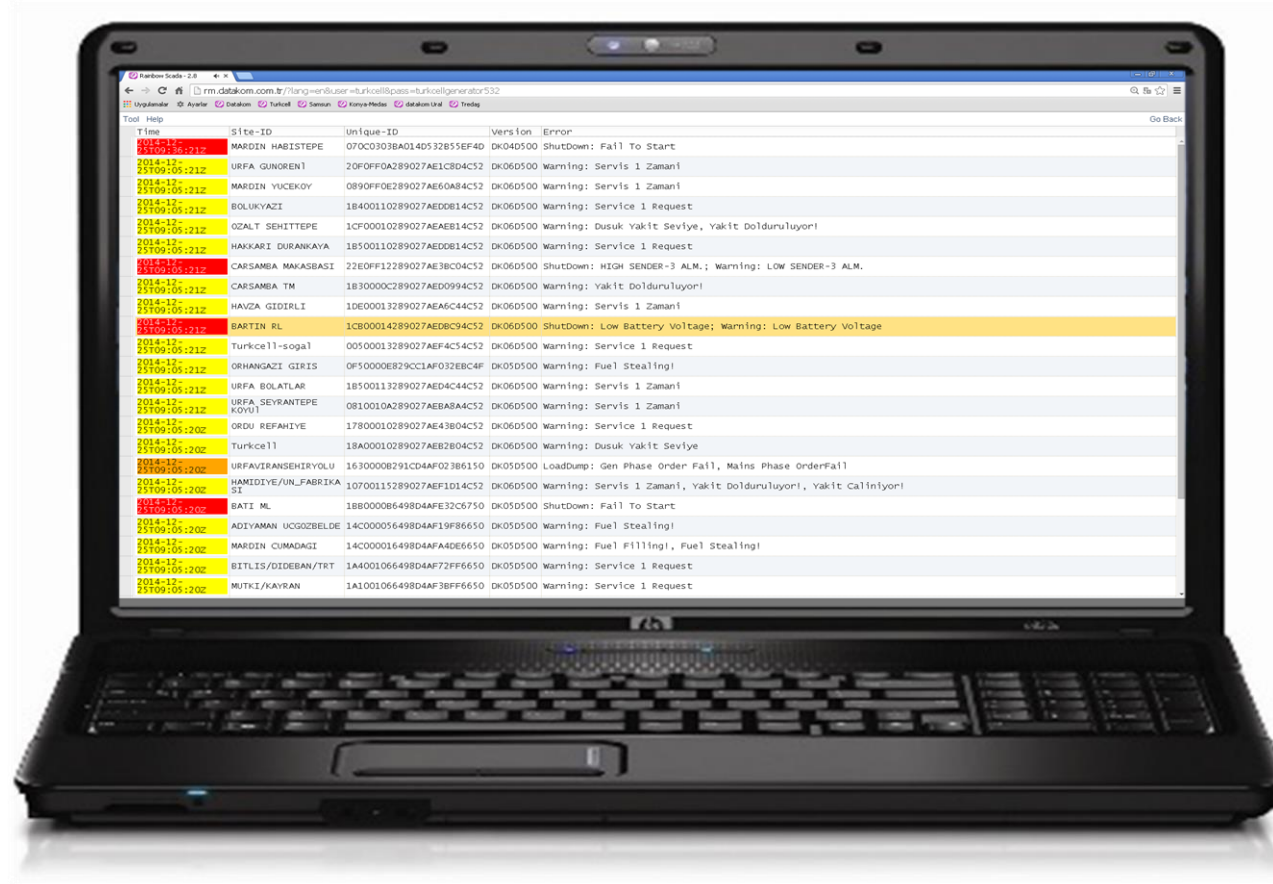

ALARM HISTORY IS RECORDED INTO DATABASE



CUSTOMER LOGIN HISTORY RECORDING

MONITOR SUB-USER ACTIVITIES

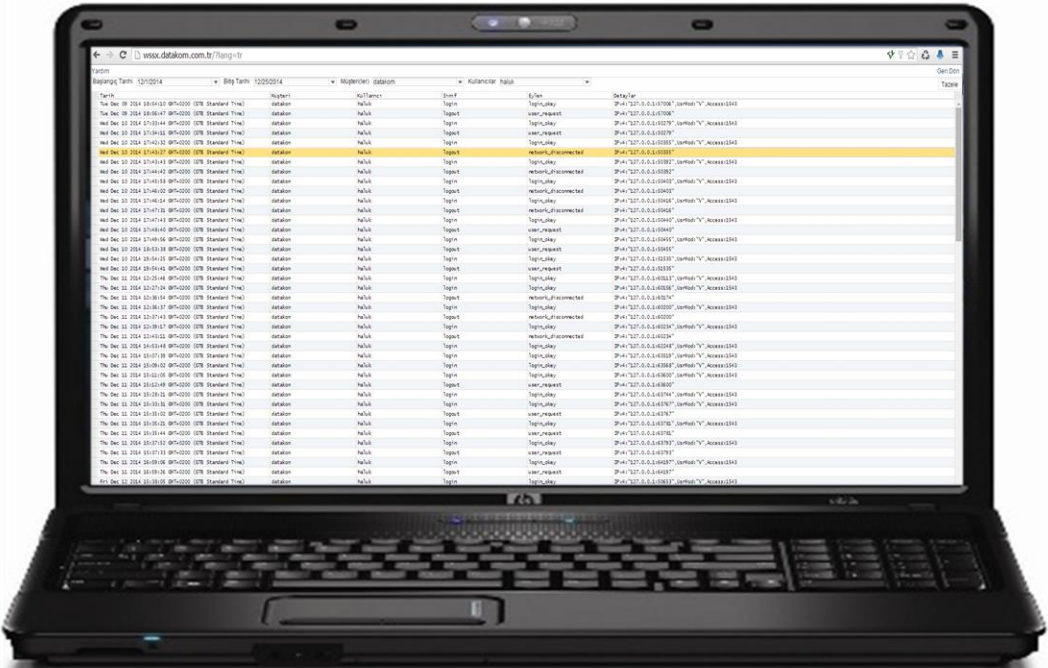

LOGIN HISTORY IS
RECORDED INTO
DATABASE

HELPS TO INCREASE SECURITY !



DETAILED REPORTING

ALLOWS TIME-FRAMED REPORTING OF SELECTED PARAMETERS



- FUEL CONSUMPTION REPORTS
- kW/fuel EFFICIENCY REPORTS
- POWER GENERATION REPORTS
- POWER CONSUMPTION REPORTS
- AVERAGE VALUES
- MIN-MAX VALUES

PROVIDES HELP FOR BETTER MANAGEABILITY OF YOUR FLEET !



REMOTE CONTROL OF AUXILIARY DEVICES

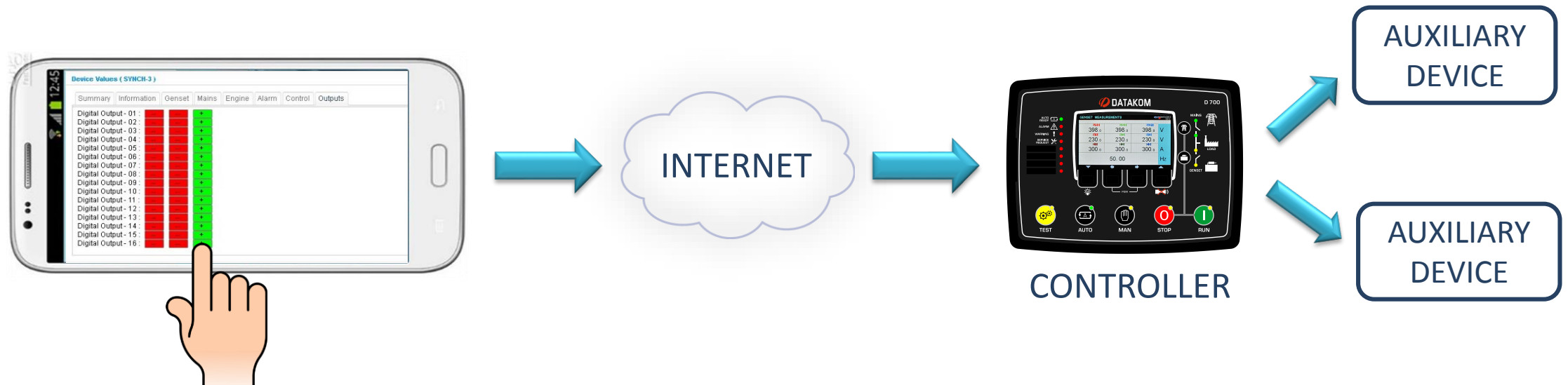

MONITOR ALL DATAKOM PRODUCTS



INTEGRAL APPROACH

MONITOR THIRD PARTY PRODUCTS

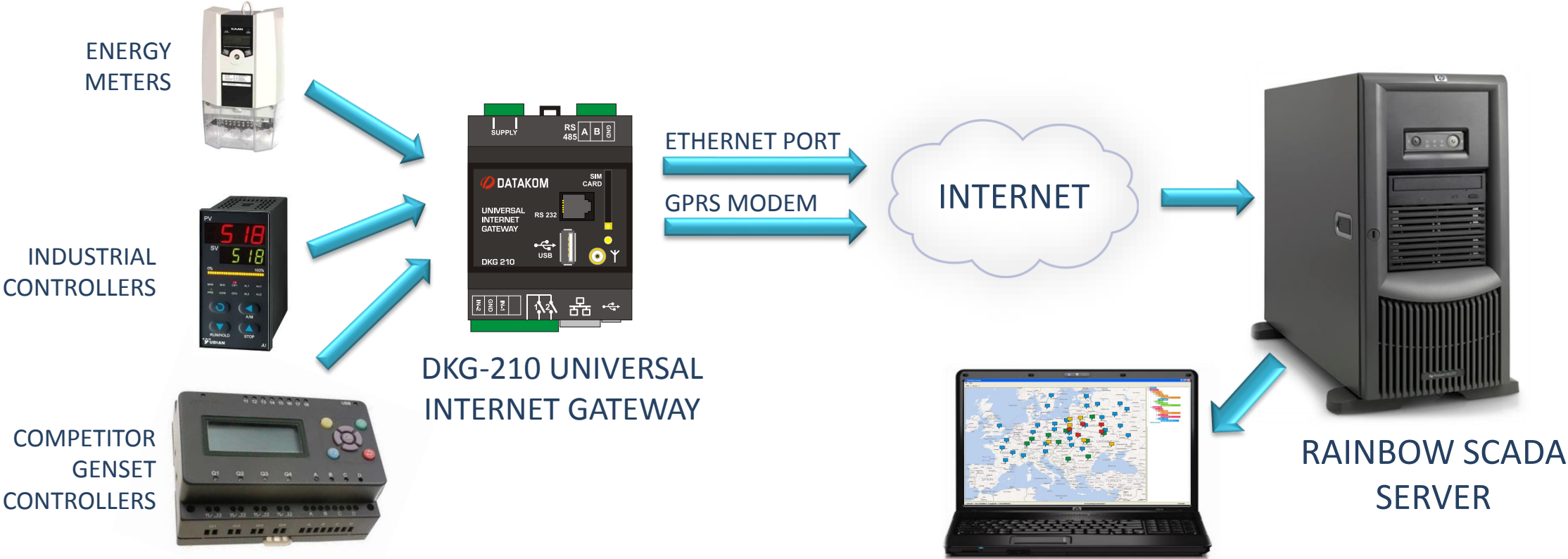

COST ADVANTAGE

MONITOR YOUR SYSTEM WITH LOWER DATA COST !

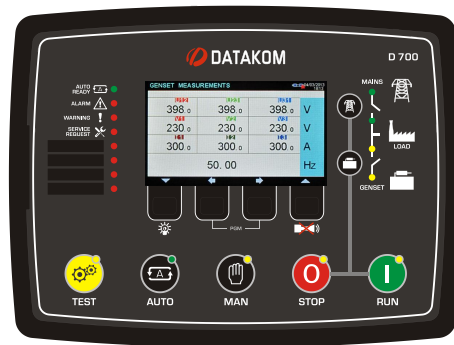

CONTROLLER



RAINBOW SCADA
SERVER

- CONTROLLERS CONNECT AUTOMATICALLY
- NO NEED TO QUERY THE CONTROLLER
- ALL DATA IS SENT IN A SINGLE IP PACKET



COST ADVANTAGE

EACH CONTROLLER COMES WITH 2 YEARS FREE MONITORING

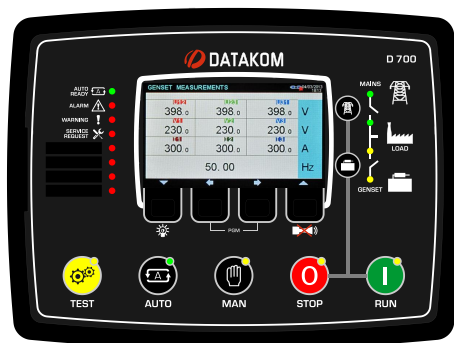

- 2 YEARS FREE MONITORING
- 6 MONTHS FREE REMOTE CONTROL
- 6 MONTHS FREE REMOTE PARAMETER EDIT
- 6 MONTHS FREE DATA ANALYSIS



IMMEDIATE FAULT DETECTION

REDUCE CUSTOMER'S DOWN TIME WITH FASTER INTERVENTION



YES !



NO !



FAULT SENSING BEFORE FAILURE

GENERATE ALERTS BEFORE THEY BECOME EMERGENCIES



LOW FUEL

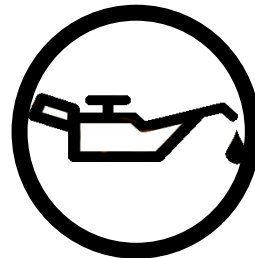

LOW OIL

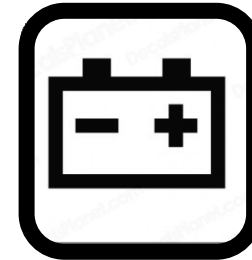

LOW BATTERY

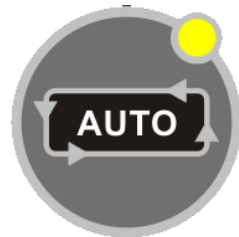

NOT IN AUTO



SERVICE REQUEST



REMOTE FUEL FILLING MONITORING

CONTROLLER COUNTS FLOW METER PULSES

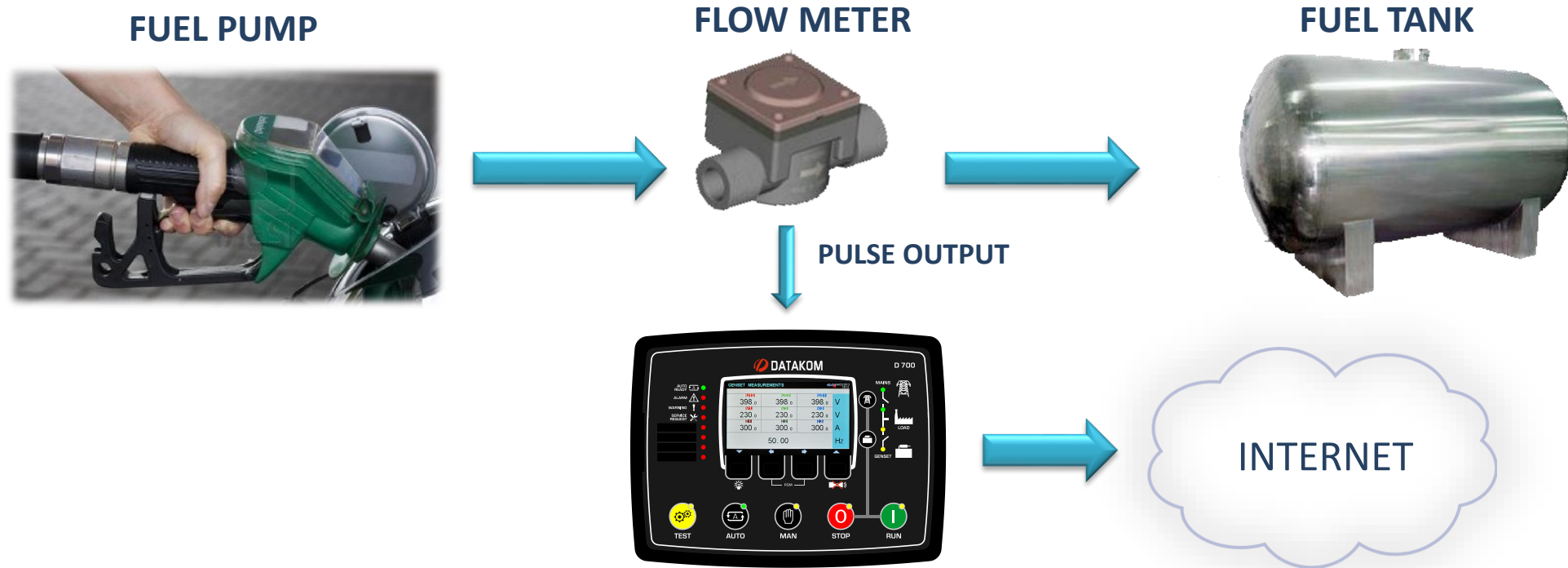

SAVE YOUR MONEY BY ELIMINATING FUEL FILLING FRAUDS !



FUEL CONSUMPTION MONITORING

CONTROLLER COUNTS FLOW METER PULSES

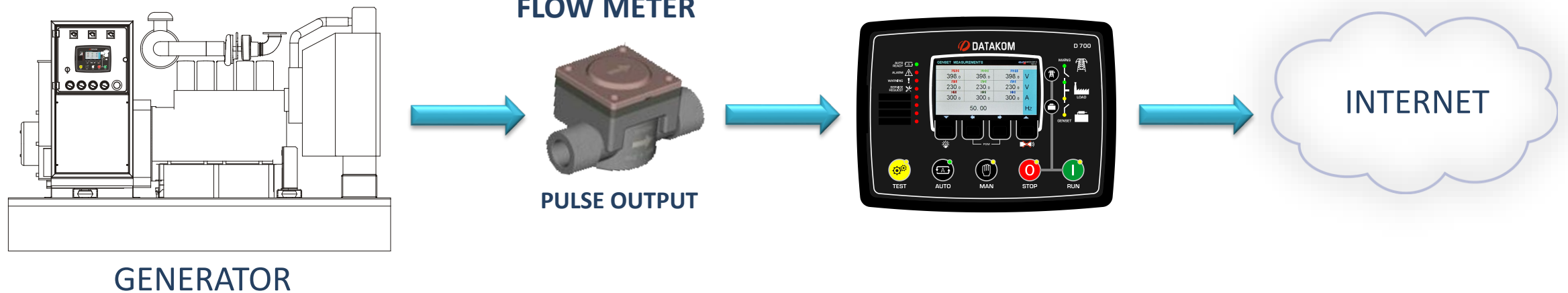

MONITOR YOUR GENSET'S kw/FUEL EFFICIENCY



REMOTE SERVICE MONITORING

REDUCE YOUR SPARE PARTS COST BY SERVICE PLANNING !

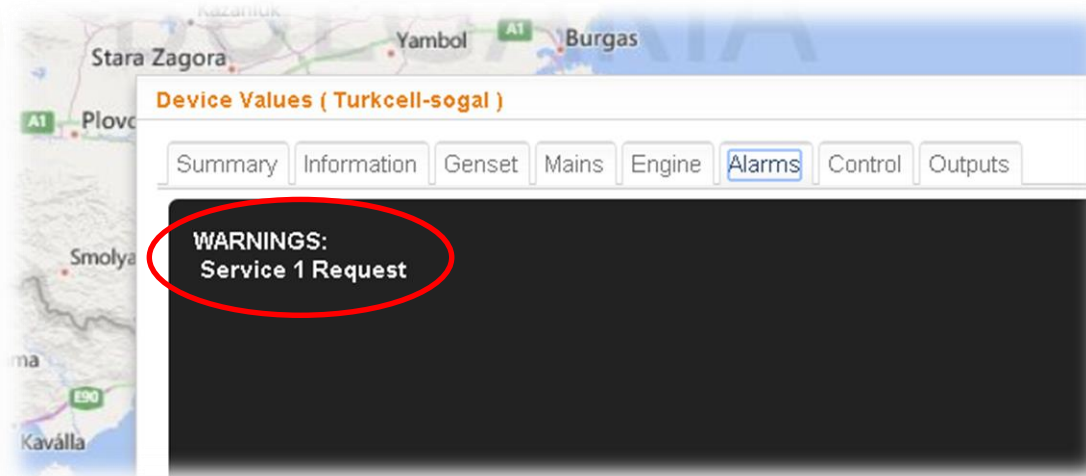
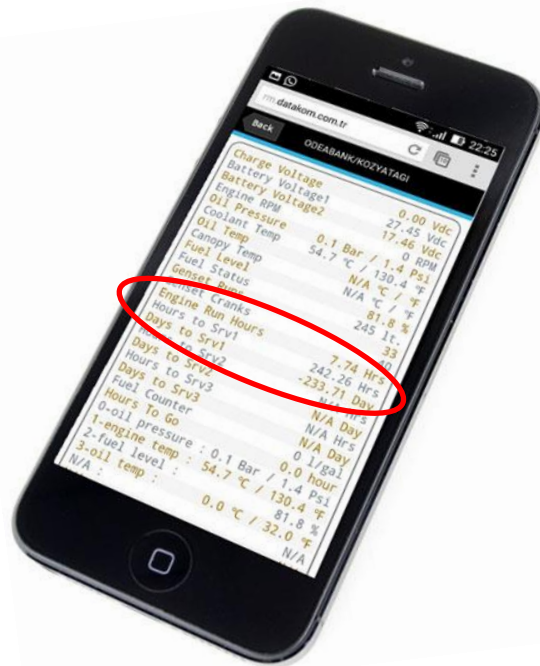

AVOID UNNECESSARY SERVICE VISITS



LESS MANPOWER FOR SERVICE

AVOID UNNECESSARY SITE VISITS



NO !



YES !



ADVANTAGES

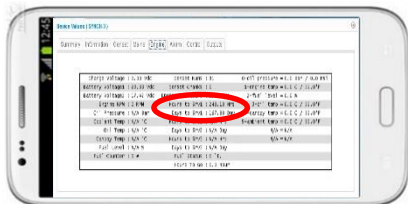
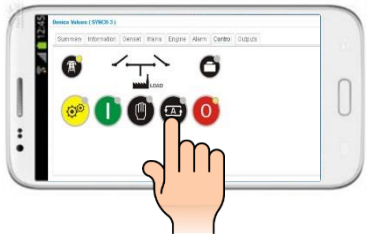

- ❑ GENERATE ALERTS BEFORE THEY BECOME EMERGENCIES
- ❑ RESET FAULTS FROM YOUR CONTROL ROOM
- ❑ TEST YOUR GENSET FROM YOUR CONTROL ROOM
- ❑ REDUCE YOUR DOWN TIME WITH FASTER INTERVENTION
- ❑ AVIOD UNNECESSARY SITE VISITS
- ❑ REDUCE YOUR SPARE PART COST BY SERVICE PLANNING
- ❑ ELIMINATE FUEL THEFT
- ❑ ELIMINATE ENERGY THEFT
- ❑ ELIMINATE FUEL FILLING FRAUDS
- ❑ HAVE YOUR CRITICAL SITE ALWAYS UP
- ❑ HAVE DATA SECURITY
- ❑ INTEGRATE THIRD PARTY PRODUCTS IN THE SAME NETWORK
- ❑ CONTROL YOUR ENTIRE REMOTE STATION VIA D-500

